



Enapter

Indoor Cabinet

For Enapter Systems 2.1 and Up

Installation Manual



Version	Document Title	Release Date
07	Enapter Indoor Cabinet for Modules 2.1	26 May 2021

PREFACE

Thank you for choosing the Enapter Indoor Cabinet 2.1. Please study this manual carefully before placing the unit into service.

If you have any further question on the installation of the device, please contact the Enapter support team. Quote the system serial number when contacting us; you can find this inside the cabinet towards the back of the plinth.

Enapter Srl

Headquarters: Via di Lavoria 56/G

56040 Crespina (PI) – Italy

T.: +39 050 644 281

Website: www.enapter.com

VAT no. 13404981006

Scope of the document

This manual provides the installers, users and owners with the information needed to carry out the installation of the CAB2.1 safely and as intended.

Keep this manual in a safe place and readily available. Always follow its instructions. It is the operator's responsibility to ensure that an installed electrolyser system is in proper condition at all times. Please observe any additional local requirements applicable to the installation and operation of the hydrogen generator system. This owner's manual functions as a general document, it covers installation, maintenance, and operation.

Approved use

The CAB2.1 has been designed to hold other Enapter modules, which produce pure Hydrogen that can be used directly for Fuel Cell or other Hydrogen consuming applications.

The unit must only be operated for this purpose, according to the specifications and instructions provided in this manual.

Observance of this manual is part of "normal use".



Version	Document Title	Release Date
07	Enapter Indoor Cabinet for Modules 2.1	26 May 2021

Table of Contents

PREFACE.....	2
PRODUCT OVERVIEW	4
Technical Specifications	7
SAFETY INSTRUCTIONS	8
List of Hazards	10
CABINET INSTALLATION	13
Tools, material and accessories required	13
Placing the cabinet	14
Dimensions	15
Cabinet safety considerations	16
Electrical connections	17
MODULE INSTALLATION	19
Module assembly: Gas, Water and power connections	19
Electrolyser connections.....	22
Dryer connections.....	23
Water tank module connections (OPTIONAL)	24
Gateway.....	25
EXTERNAL CONNECTIONS.....	26
Vent management design.....	29
Management of airflow	30
FIRST TIME SETUP OF THE CABINET SYSTEM	31
TRANSPORT, MAINTENANCE AND RECYCLING	31
Routine maintenance	31



Version	Document Title	Release Date
07	Enapter Indoor Cabinet for Modules 2.1	26 May 2021

PRODUCT OVERVIEW

The Enapter’s cabinet 2.1 is a complete solution for hydrogen production which usually includes several modules joining the hydrogen and purge outlets into unified outlets. It also has a single input for water and electricity which it distributes internally as appropriate for each module.

Front

The front door of the CAB2.1 is fully perforated, allowing all devices to take in air unobstructed (Figure 2). The door swings open by 180 degrees. It is possible to directly place several CAB2.1s beside each other by locking the cabinets together (Figure 1).



Figure 2: Front door



Figure 1: Cabinets attached to each other



Version	Document Title	Release Date
07	Enapter Indoor Cabinet for Modules 2.1	26 May 2021

[Back](#)

The back panel of the CAB2.1 (Figure 3) is used to blow out warm air. Please leave at least 50 cm space behind the module to allow for adequate airflow. Never obstruct the ventilation openings! The rear doors swing open by 40 cm.



Figure 3: Back door



Version	Document Title	Release Date
07	Enapter Indoor Cabinet for Modules 2.1	26 May 2021

External connections

All outlets and inlets of the CAB2.1 are managed on the rear side of the plinth (Figure 4), with the exception of the “Vent Outlet” located on the right-hand side of the cabinet’s roof (Figure 5).



Figure 4: Plinth rear connections



Figure 5: Cabinet roof



Version	Document Title	Release Date
07	Enapter Indoor Cabinet for Modules 2.1	26 May 2021

Technical Specifications

	CAB2.1
Dimensions	Width: 800mm Depth: 800mm Height: 2200mm
Cabinet Type:	Rittal DK 5507.181
Weight	180 kg (empty)
Enapter EMS Gateway	Wireless (Wi-Fi, Bluetooth), Ethernet Included in every cabinet
Safety	
Max outlet pressure:	35 bar
Ventilation and Safety Recommendation	Required ventilation depends on room size, Hydrogen detection system with an integrated safety circuit is recommended
Environmental	
Operating Conditions	5°C to 45°C, up to 95% humidity, non-condensing
IP Rating	20
Demineralised water input	Max. conductivity at 25°C < 20 µS/cm
Water input pressure:	0.75-4 bar
Battery Limits	
H ₂ Outlet	1/4 " Swagelok Tube Fitting
Vent Outlet	10 mm Push Fit
Purge Outlet	1/4 " Swagelok Tube Fitting
Water Inlet	8 mm Push Fit
Fill and Drain Port	CPC quick connector 10 mm on each Electrolyser



Version	Document Title	Release Date
07	Enapter Indoor Cabinet for Modules 2.1	26 May 2021

SAFETY INSTRUCTIONS

Warnings and Hazards

The following terms and symbols are used in this manual to indicate important text passages which must be given particular attention:



Warns of fatal/serious injury



Warns of injury



Warns of physical damage to the product



Do not open or dismantle



Keep away from sources of heat and ignition.
No naked flames



No smoking



Minimum two persons required to handle the item



Wear Personal Protective Equipment



Wear hearing protection

General safety

Any user, installer and operator must be aware of the following:

1. The machine is **not intended** to be used in a potentially explosive area
2. **We decline any responsibility resulting from improper use of the CAB2.1, including**
 - a. Problems caused by leaking gas connections on the battery limits of the cabinet
 - b. Problems caused by improper installation of the machine
3. With regards to the **design and installation of the hydrogen outlet, purge and vent lines**; the customer must follow Enapter's installation guide, but also ensure full compliance with local safety guidelines and regulations.
4. It is the installers/users or owners responsibility to **regularly check and maintain the purge and vent lines**, as well as to keep the lines free of ice or obstructions.
5. It is the installers/users or owners responsibility to keep the air inlets/outlets free of obstructions.

The following rules should always be observed:



Version	Document Title	Release Date
07	Enapter Indoor Cabinet for Modules 2.1	26 May 2021

1. **Keep the work area clean.** Clutter can create hazards around the device. Keep the work area well illuminated.
2. **Do not use the machine in explosive atmospheres.** Do not place the cabinet near flammable substances.
3. **Handle** the power supply cable with care. **Do not pull** on the electric cable, and ensure the power is cut before installing the cable. Keep the electric cable away from heat, oil and sharp edges.
4. **Protect yourself** from electric shock. Avoid any contact with earthing surfaces.
5. **Never expose** the device to rain or very damp conditions.
6. **Keep children and people without explicit knowledge** of the device and its function away to a safe distance.
7. **Only use** demineralised water according to the specification stated in this manual
8. **Never operate** the device in confined spaces without additional safety infrastructures, such as active ventilation or hydrogen detection systems.
9. **Always wear personal protection devices**
 - a. **Wear ear muffs or plugs** in noisy areas
 - b. **Wear gloves when handling the device.**
 - c. **Wear appropriate footwear** when handling the cabinet.
 - d. **Use lifting aids** when available when lifting the cabinet.
10. **Always disconnect** the machine from electricity before any maintenance and transport.
11. **Only use** the machine in the way and for the purposes mentioned in this manual. If the machine is utilised for uses other than what is specified in this manual, unforeseen hazards may present themselves.
12. **Use the handles** when lifting and moving the device.
13. **Never attempt to repair the machine** by yourself. The machine must be repaired only by qualified people who use original spare parts; otherwise, risks may arise for the operator.
14. **Do not store** the unit at temperatures below 2°C.



Version	Document Title	Release Date
07	Enapter Indoor Cabinet for Modules 2.1	26 May 2021

List of Hazards

Any system-operator, -integrator, end-user and technician who operate, service, maintain or install the device must be aware of the potential dangers associated with its use, in order to implement sufficient processes in case of an accident or emergency.

While the CAB2.1 is a passive device and does not produce any particular hazards, the systems contained within the CAB2.1 must have their hazards managed. The most common hazards encountered by using the CAB2.1, with a standard configuration, are listed below.

Always ensure that the system is installed and operated in compliance with local code, regulations and standards. Do not install, operate or maintain the system without explicit knowledge or help from experienced and licensed system integrators, the manufacturer or external certifying bodies.

Hydrogen hazard

Hydrogen itself is not a hazardous substance – however, its properties can make it hazardous in interaction with other substances and environments.

It is a User's responsibility to implement a safety system to manage the CAB2.1's outputs – more information about this is below.



Danger of explosion – exploding Hydrogen can kill.

Leaking Hydrogen can ignite and burn the skin.

High levels of hydrogen concentrations can cause asphyxiation!

Do not inhale Hydrogen – be safe.

Do not use without a suitable ventilation and safety system in place!

Incorporate the unit, especially the vent line, into the operational safety concept.

The lab/room must be equipped for hydrogen monitoring.

Avoid heat in the vicinity of the system and the hydrogen source.

No smoking, no naked flames.

Comply with local safety regulations.

Comply with regulations for the handling of compressed hydrogen cylinders.

In the case of escaping gas, keep away and keep inflammable materials away.

Prevent electrostatic charging of the device.

Ensure proper installation of the hydrogen supply.

Check the hydrogen lines and connectors regularly for leak tightness





Version	Document Title	Release Date
07	Enapter Indoor Cabinet for Modules 2.1	26 May 2021

Mechanical Hazards

Generic mechanical hazards are often ignored and commonly cause injuries. To avoid this, we recommend wearing appropriate Personal Protective Equipment (PPE) and using suitable tools at all times when handling the device and packaging material.

While the handling of the packaging material and preliminary installation does not require specialised technicians, a general training with regards to lifting heavy loads and general safety briefings are required to perform these tasks safely.

Operators must comply with the general safety principles during the handling phases. In particular:



Caution!

Before handling, moving and commissioning the system – assess the hazards of the operation and study the manual. Appropriate PPE must be worn, such as cut resistant gloves, safety shoes, protective goggles, etc. depending on the activity. Ensure to clear the area of work before starting to mount the device.



The device is heavy and must be lifted by at least 2 people – plan around this and allow ample space to move around. Do not lift the cabinet over your head.



Caution!

During handling of the device, be cautious and use the handles on the device to minimise the mechanical risks, such as:

- Impacts and crushing injuries due to uncontrolled movements of the load
- Dropping the device, causing crushing injuries
- Loss of stability, leading to entanglements and other injuries.

The packaging/cabinet must be handled **by at least two people**.

Electrical hazards

The unit poses no special electrical hazards, as long as the following instructions on safety measures are observed and the [Electrical Connection Guide](#) below is applied correctly:

Caution!

- Handle the electrical installation with care. Ensure that the plug is fastened into the connector to avoid any loosening of the wiring.
- Use only the supply voltage specified on the rear of the device.
- Do not short-circuit inputs and outputs.
- Do not reverse the polarity of inputs and outputs.
- Do not insert any mechanical parts, especially metal parts, into the product through the ventilation slots.
- Do not use liquids near the product.
- Never use the product if any part of it has been immersed in water.



WARNING!

Always remove the power supply when the product is being cleaned, maintained or transported.

Any servicing, other than cleaning and routine user maintenance, must be performed by trained, Enapter-endorsed technicians.





Enapter

Version	Document Title	Release Date
07	Enapter Indoor Cabinet for Modules 2.1	26 May 2021

Environmental hazards

The CAB2.1 has not been designed for outdoor use and is intended for use in standard ambient conditions, respecting stability requirements (in the absence of seismic or hydrogeological events of particular intensity). It is the User's responsibility to protect the system and all its accessories against atmospheric phenomena such as direct sunlight, rain, snow and lightning.



Version	Document Title	Release Date
07	Enapter Indoor Cabinet for Modules 2.1	26 May 2021

CABINET INSTALLATION

Please refer to the “**General safety**” section for a detailed list of instructions – it is required for all installers and technicians to follow these general set of rules as a minimum precautionary measure to allow the safe installation and commissioning of the system. **Any person working on the system must be familiar with the hazards and risks associated with installing, commissioning and running the modular electrolyser systems contained within.**

The cabinet 2.1 is designed to allow the most uncomplicated integration of Enapter products, while also enabling hot-swapping of modules with the integrated valves and vent management system. The modules are simply mounted by sliding them into their respective slots and connected to with premade piping assemblies.

All the cabinet-internal cabling and piping is prepared and leakage tested by Enapter. However, it remains the customer’s responsibility to provide the connection to any external system for the respective piping and tubing at the rear end of the cabinet.

Tools, material and accessories required

The following tools and equipment are needed to set up the device successfully.

Tools

- 9/16 combination wrench
- 5/8 combination wrench
- Plastic pipe cutter
- Phillips head screwdriver
- Stainless steel pipe cutter
- ¼” Tube Bender



Materials

- Stainless steel AISI 316- ASTM A269 -1/4” X 0,89
- 8mm Ø LLDPE pipe
- 10 mm Ø LLDPE pipe





Version	Document Title	Release Date
07	Enapter Indoor Cabinet for Modules 2.1	26 May 2021

Unpacking

The unit has been carefully inspected before shipping. Visual checks for damage and functional tests should be performed upon receipt.

Please do not dispose of the original shipping materials. We will not accept the unit if returned without the original shipping boxes or equivalent for safe transport. In the case that you cannot keep the shipping boxes, please recycle responsibly.



Attention! If any damage has occurred during transport, please report this immediately to the shipping agent and supplier. Afterwards, the unit should be returned according to the shipping instruction provided in this manual, in the section [“Transport, Maintenance and Recycling”](#).



Warning!
Use lifting aids if available.
Due to their weight and size, it is recommended to use a pallet cart or similar devices to manoeuvre the box upon delivery.

Placing the cabinet

The standard cabinet is designed for indoor use or to be shielded from the elements. Due to the perforated front and back doors the protection rating for the system is IP20. Therefore, the system needs to be protected from water, and care should be taken to minimise the amount of dust ingress. In addition, direct contact with sunlight should be avoided.

For indoor use, it is important to ensure proper ventilation in the room of the hydrogen generator system. The ventilation must allow any hydrogen which may leak from the installation to escape and be diluted with more air. It is recommended to install fans at the roof of the room with the air intakes near the floor and to monitor the hydrogen concentration in the installation room to ensure that the hydrogen concentration is far below the flammability limit at all times.

It is highly recommended to place the cabinet on a properly designed surface, which is flat, level, vibration and shock-free. Do not place the unit near a source of heat, as this may cause the device internal temperature to overheat the enclosed systems. Do not operate the unit in close proximity of flame or other sources of ignition. Do not modify or operate the cabinet outside the herewith described operating instructions, as the cabinet contains safety-critical systems to help manage the in- and outputs of the hydrogen generator systems.



Do not modify the cabinet

An area of 1.2 m depth should be left clear in front of the system to ensure proper operation and in order to carry out maintenance and service work. A minimum of 0.5 meters is necessary for the back of the cabinet to install piping and connections and to allow hot air to pass out of the system unobstructed. The sides of the cabinet do not require extra space. A multitude of cabinets can be mounted together (side by



Enapter

Version	Document Title	Release Date
07	Enapter Indoor Cabinet for Modules 2.1	26 May 2021

side) to freely form larger systems. For information about this, please look at Rittal product item code: DK 5507.181.

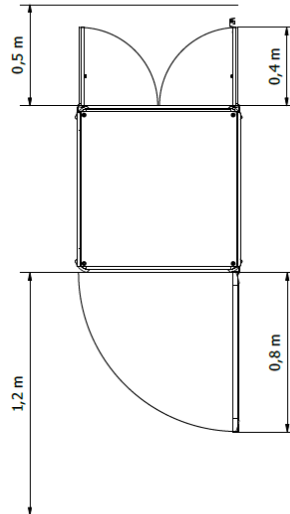

It is recommended to bolt the system to the floor with 4 screws using the holes in the plinth of the cabinet. Make sure to adjust the system until it stands level.

Dimensions

The final dimensions of the cabinet, with its side panels attached, are 2200x800x800 mm.



Version	Document Title	Release Date
07	Enapter Indoor Cabinet for Modules 2.1	26 May 2021

Cabinet safety considerations

While the CAB2.1 is a passive device, its intended use is to contain, connect and manage the outputs of the modular Enapter electrolyser systems. This allows the User/system integrator a greatly simplified installation process. It should be noted that the safety and installation instructions from the contained modules transfer onto the cabinet outlets, whose bulkheads and connections directly mirror the available input connections from the individual Enapter modules.

The cabinet is equipped with water and gas pipelines (**W1.1.1** “Vent/overfilling” and **H1.2** “Hydrogen purge”), these must be connected and leak tested from the contained module to the bulkheads on the cabinet, by the Installer/User. Any further instructions as given by the device user manuals must be adhered to.

The User/Installer must comply with all safety instructions described in the section “Safety instructions”. In particular, please refer to EL21, DRY and WTM manuals for detailed information about integrating them into larger systems.

- **Do not place the device into a sealed or unventilated room**
- **Do not place flammable materials in the proximity of the device**
- **Do not use naked flames/do not smoke**

Avoid any risk of flammable/explosive concentrations of Hydrogen in and around the cabinet.

Version	Document Title	Release Date
07	Enapter Indoor Cabinet for Modules 2.1	26 May 2021

Electrical connections

1. Push the electrical conduit into the fitting, to the stop (the conduit diameter must be 42,5 mm in \varnothing according to the relating port).
2. Gently pull on the conduit to check it is secure.
3. To disconnect, push the collet square against the fitting. With the collet held in this position, the conduit can be removed.



Figure 6: Power supply bulkhead union



To connect power to your hydrogen generator system a cable of suitable specification, sized for all equipment to be mounted in the cabinet, needs to be fed through the corrugate inside the cabinet into the terminal blocks. It is important to size the power cable according to the power of the equipment installed.

Connect the mains to the terminal blocks placed on the bottom part of the cable duct on the right side of the cabinet, as shown in Figure 7.



WARNING!
Never work on live wires!

Version	Document Title	Release Date
07	Enapter Indoor Cabinet for Modules 2.1	26 May 2021

The wires have to be placed in the respective lodgings through the power port referring to the stickers “G” (ground), “N” (neutral), “L1”, “L2” and “L3” (phases).

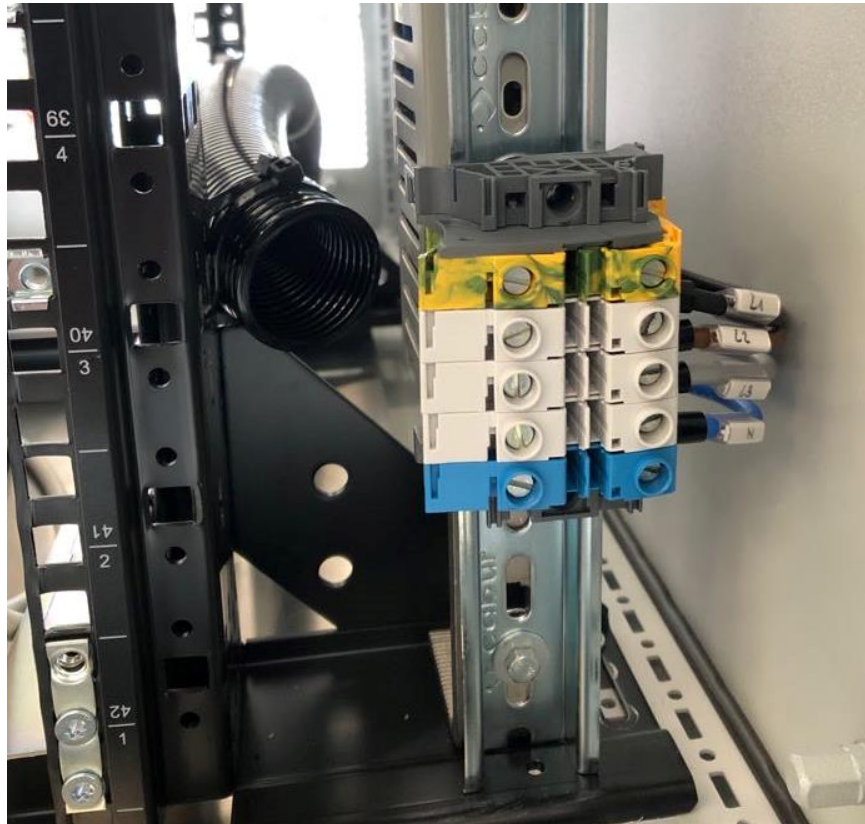

Figure 8: Power line terminal blocks

We also recommend installing a protective device against overload and short circuits on the power supply line. The protective device must be selected in relation to the cabinet’s maximum power consumption and in compliance with all local and national safety requirements.

We recommend installing an SPD (Surge Protection Device) on the power supply line to protect the hydrogen generator system from potential over-voltages generated by lightning strikes.

It is the installer’s responsibility to correctly dimension and install all electrical equipment upstream of the cabinet.



Version	Document Title	Release Date
07	Enapter Indoor Cabinet for Modules 2.1	26 May 2021

MODULE INSTALLATION

Module assembly: Gas, Water and power connections

Place the modules into the rack in the correct order (Figure 9): WTM (Water Tank Module, optional) has to stay on the bottom, DR 2.1 (Dryer) in the middle and EL 2.1 (Electrolyser) on the top. Secure the modules with the supplied screws.

Connections from the modules to the cabinet are included as standard parts for each order. These premade & labelled, please follow the instructions on the labels to attach them on the correct connector each time.

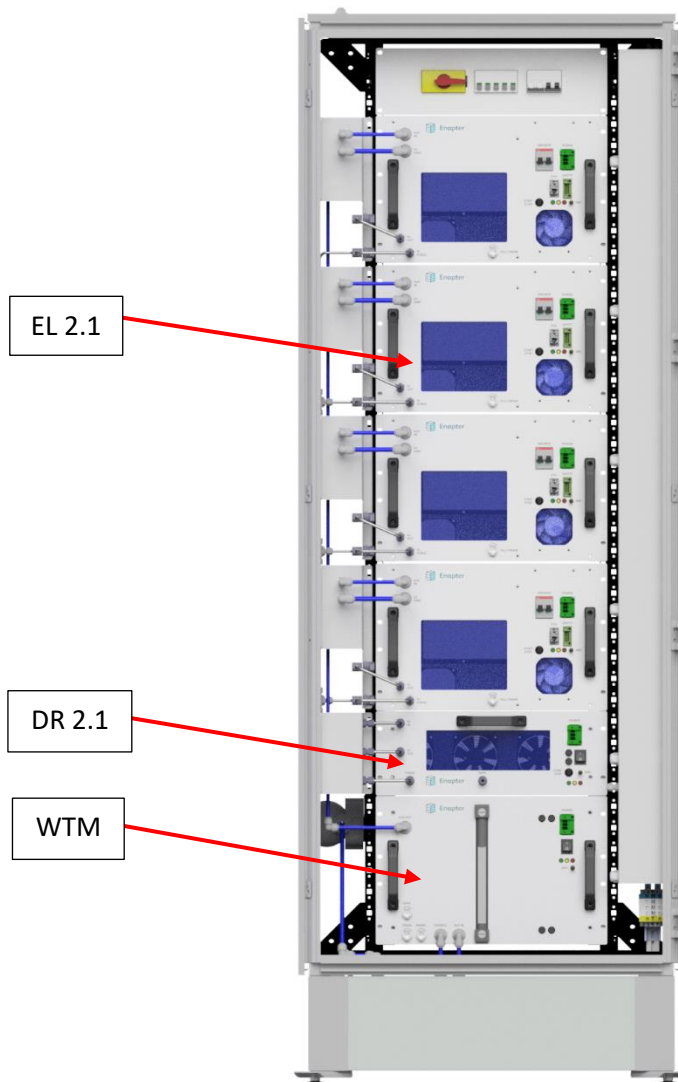
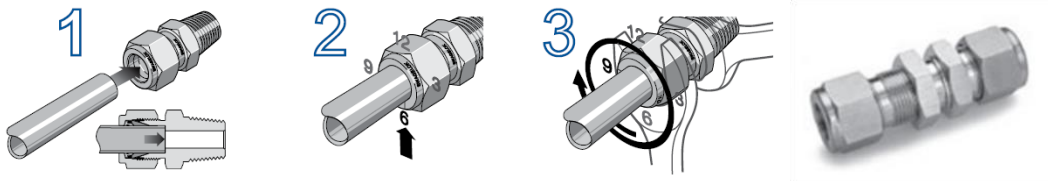

Figure 9: Modules placement

Version	Document Title	Release Date
07	Enapter Indoor Cabinet for Modules 2.1	26 May 2021

External gas line assembly instructions

Bulkhead unions: ports **H1.1** (Hydrogen outlet) and **H1.2** (Hydrogen purge)



1. Fully insert a ¼ inch stainless steel tube into the bulkhead union.
2. Rotate the nut finger-tight
3. While holding the fitting body steady with one wrench, tighten the nut with another wrench rotating clockwise.

Plastic piping connection assembly instructions

Bulkhead unions: ports **W1.1** (O₂ and H₂O outlet) of 10 mm Ø and **W1.2** (Refilling H₂O) of 8 mm Ø.



1. Cut the tube square and remove sharp edges. Ensure the outside diameter is free of score marks.
2. Push the tube into the fitting, to the tube stop (the pipe diameter must be 8 or 10 mm Ø according to the relating port).
3. Pull on the tube to check it is secure. Test the system before use.

To disconnect, ensure the system is depressurised, push the collet square against the fitting. With the collet held in this position, the tube can be removed.



Version	Document Title	Release Date
07	Enapter Indoor Cabinet for Modules 2.1	26 May 2021

Power distribution panel

The cabinet has pre-installed power cables running alongside the front panels into a cable duct. Each set of these numbered cables is connected to the respective breaker on the power distribution panel placed on the top (Figure 10). A breaker is present for each device, as well as one for the Gateway. The general safety switch is located on the left. The Gateway transformer must be plugged into the white socket placed on the back right of the panel.

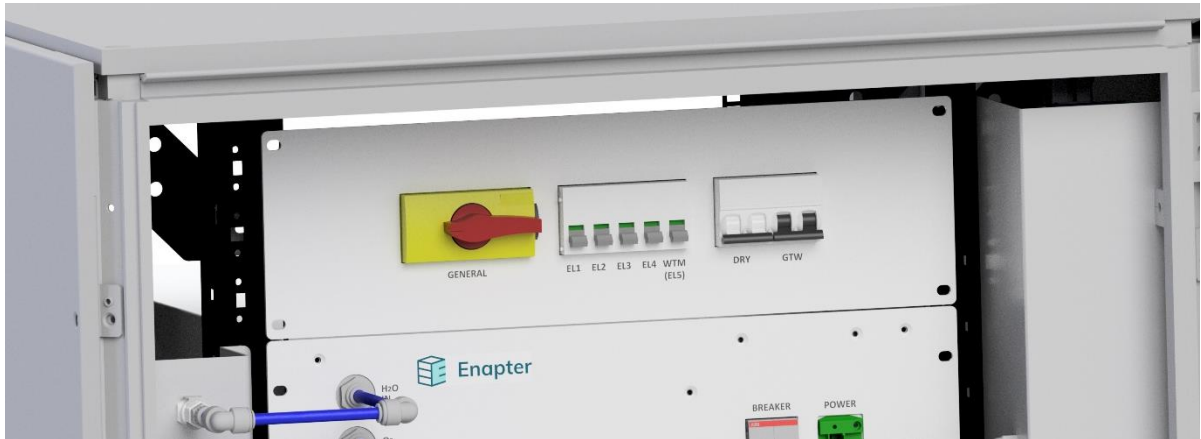

Figure 10: Power distribution panel

Version	Document Title	Release Date
07	Enapter Indoor Cabinet for Modules 2.1	26 May 2021

Electrolyser connections

Every Electrolyser has four connections on the front panel, as shown in Figure 11. Connect the water refilling line (**H₂O in** - \varnothing 8 mm - #1) and the vent line (**O₂ vent** – \varnothing 10 mm - #2) to the connectors on the panel with the supplied LDPE pipes with coupling insert. The hydrogen outlet (**H₂ out** - #3) and the purge line (**H₂ purge** - #4) must be connected on the valves attached on the panel as shown in the figure with the pre-supplied stainless steel piping. The power cable coming from the right must be plugged on the green power connector (**Power**).

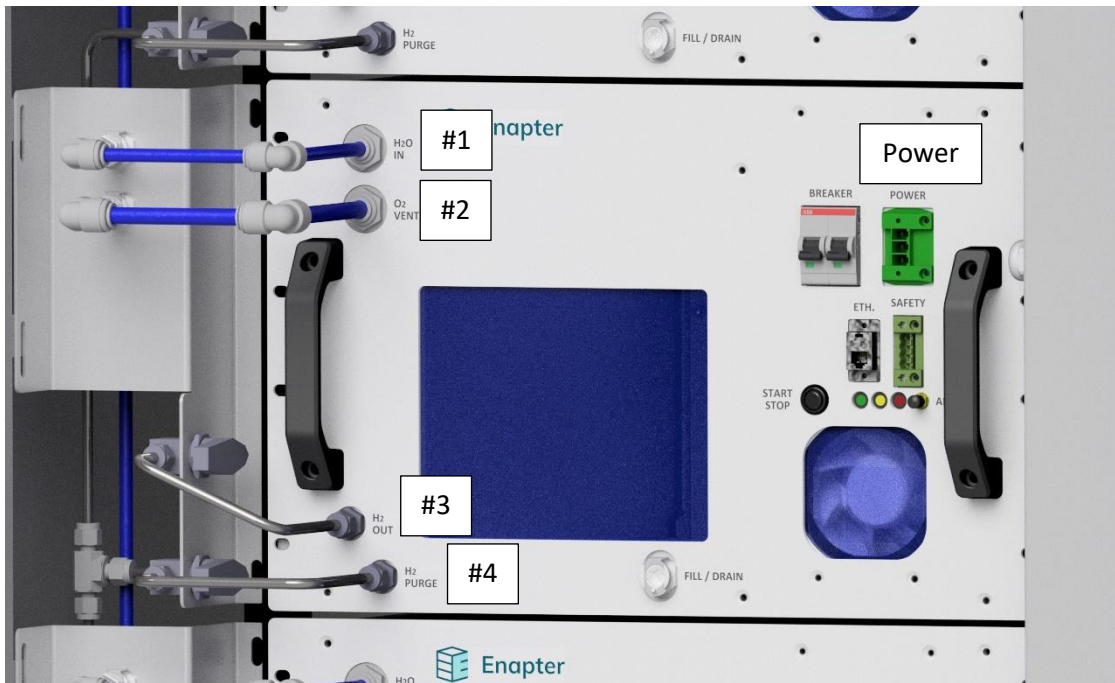

Figure 11: EL 2.1 connections



WARNING

Do not close the valves of the purge lines while Electrolysers are connected! Ensure the purge outlet of the Electrolyser is open to the atmosphere at all times to avoid damage to the device. The purge manual valves must only be shut only in case the Electrolyser is not present inside the cabinet.



Version	Document Title	Release Date
07	Enapter Indoor Cabinet for Modules 2.1	26 May 2021

Dryer connections

All the hydrogen outlets coming from the electrolyzers are connected to the bulkhead connector on the panel near the dryer. Connect this one to the **H1.1** port on the dryer with its pre-supplied piping, as shown in Figure 12. The dry Hydrogen (**H₂ outlet**) and purge hydrogen (**H1.2**) outlets should also be connected to the panel with their respective, pre-supplied piping as shown. Lastly, plug the power cable coming from the right on the green connector (**Power**).

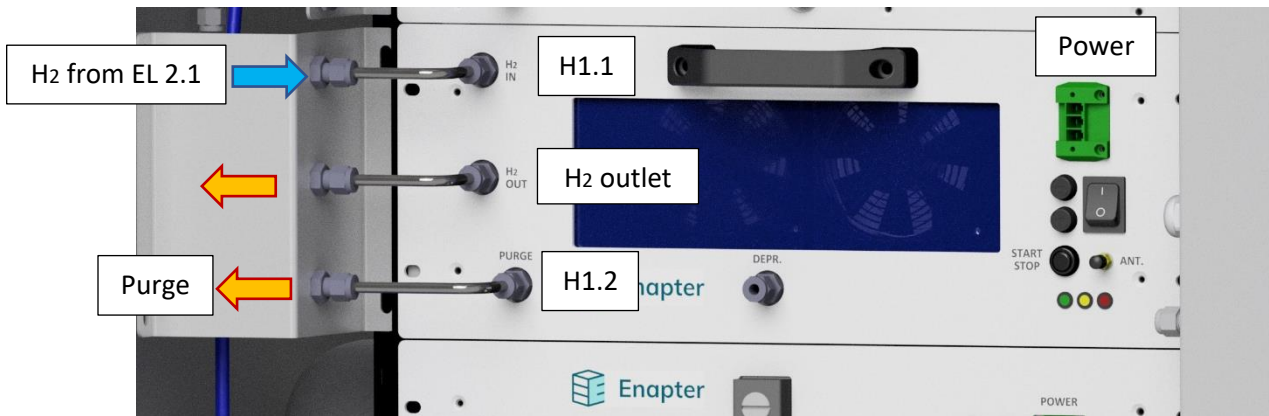

Figure 12: Dryer connections



Version	Document Title	Release Date
07	Enapter Indoor Cabinet for Modules 2.1	26 May 2021

Water tank module connections (OPTIONAL)

Connect the deionised water inlet (**W1.5**) and the overfilling Outlet (**W1.4**) with their respective connectors on the bottom plate using the supplied LDPE piping, as shown in Figure 13. The high-pressure water outlet (**W1.2**) must be connected on the water refilling line that reaches all the electrolysers. Lastly, plug the power cable coming from the right on the green connector (**Power**).

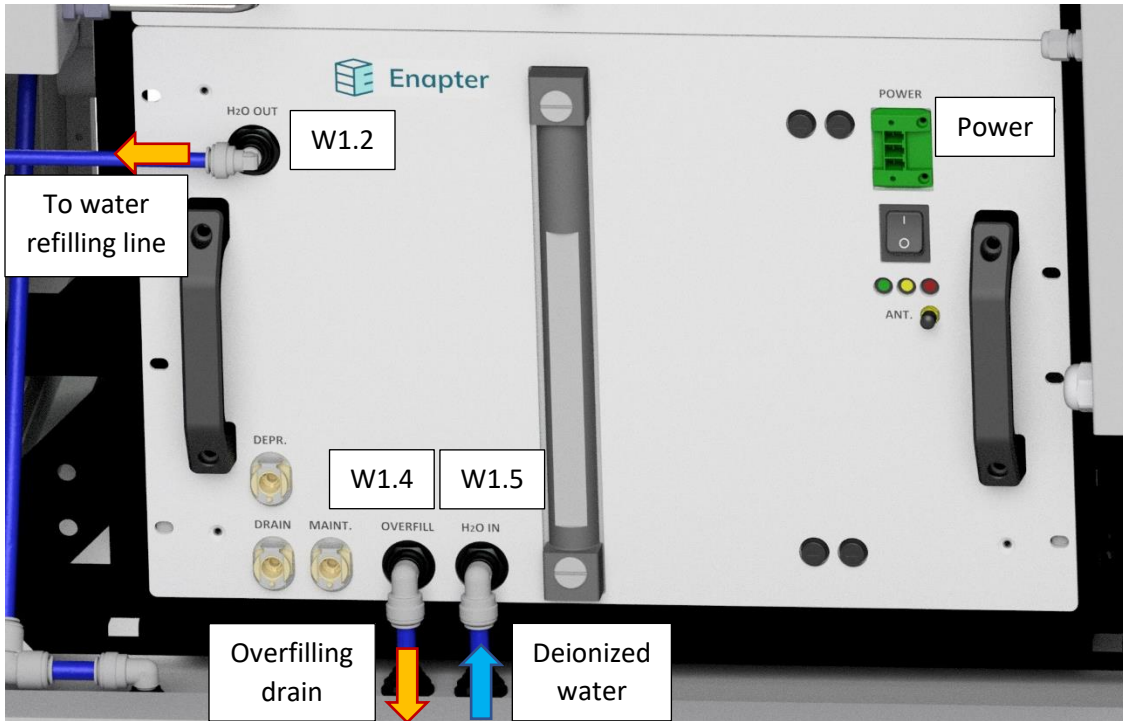

Figure 13: WTM connections



Version	Document Title	Release Date
07	Enapter Indoor Cabinet for Modules 2.1	26 May 2021

Gateway

To install the Gateway simply slide it from the top onto its mounting plate located in the back of the cabinet, behind the distribution panel, with the same orientation as in Figure 14. Make sure to insert the SD card inside and plug in its power supply.



Figure 15: Gateway

The Enapter Gateway readies your system for Industry 4.0 – to find out more, please visit <https://handbook.enapter.com/>. Instructions for setting up the gateway and how to use its easily customisable rule-based-control engine can be found here: <https://handbook.enapter.com/gateway/Welcome.html>.

Version	Document Title	Release Date
07	Enapter Indoor Cabinet for Modules 2.1	26 May 2021

EXTERNAL CONNECTIONS

The following connections are on the rear, located on the plinth (Figure 16), and on the roof of the cabinet (Figure 18).

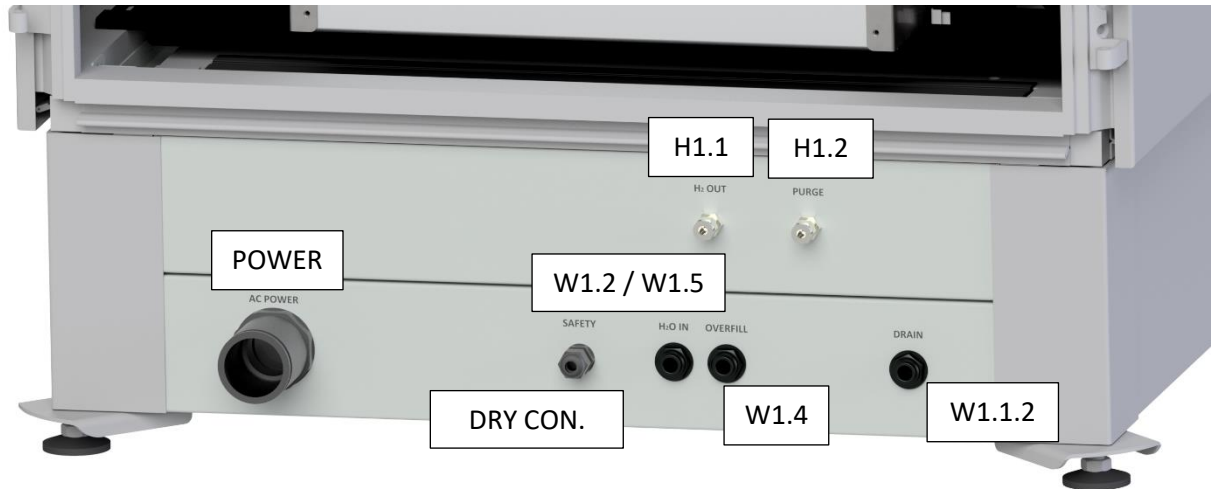

Figure 17: Plinth connections

1. Refilling port (LDPE pipe \varnothing 8 mm) (**W1.2** or **W1.5**)

Automatic refilling of the systems mounted in the cabinet. Connect a DI water pipe to this bulkhead to supply the cabinet with clean water [$< 20 \mu\text{S}/\text{cm}$ (at 25°C)]. The port will be labelled as W1.5 if the cabinet is equipped with a Water Tank Module.



WARNING

If no WTM is installed, in order to supply the CAB2.1 hydrogen generator with clean DI water for refilling, the water must have a pressure between 0.75 bar and 4 bar. If the EL 2.1 does not detect the water presence, the system will not be able to refill.

2. WTM overfill port (LDPE pipe \varnothing 8 mm) (**W1.4**)

W1.4 is the overfilling port of the tank. If no water tank module is installed, this port should be closed with a cap.

3. DRY CON.

A normally closed safety device can be attached to all the electrolyzers using this exit. Please refer to the electrolyser 2.1 manual regarding the installation of this feature.



Version	Document Title	Release Date
07	Enapter Indoor Cabinet for Modules 2.1	26 May 2021

4. Purge (stainless steel pipe $\varnothing 1/4''$) (H1.2)

From this port, Hydrogen gas can be expelled to depressurise the device or any other time it is required by the hydrogen generation process. This port must be connected with a steel pipe and vented into an external safety area. Follow the system-specific instruction on how to manage the safety area.



WARNING

The purge line should never be blocked and should always be able to equalise its pressure to the atmospheric pressure. Do not install any check valves on the line, as this damages the stacks in the Electrolysers.

5. H₂ Outlet(stainless steel pipe $\varnothing 1/4''$) (H1.1)

From this port, the Hydrogen produced by the system can be connected to a storage tank or other User devices.



WARNING:

Upon installation of the external gas line, we recommend the User to perform a hydrogen leakage test.

Version	Document Title	Release Date
07	Enapter Indoor Cabinet for Modules 2.1	26 May 2021



Figure 19: Vent connection

6. O₂ vent (LDPE pipe ø10 mm) (**W1.1.1**)

Humid O₂ with a small percentage of H₂ is continuously vented from this port during operation; therefore, it must be connected with a plastic pipe and vented into an external safety area. See the section “*Vent Management Design*” for more information.



WARNING:

Never connect the pressurised water supply pipe to any outlet/vent of the system as this damages the hydrogen generators. Ensure to connect the water supply to the correct port!

7. Vent water drain/overfilling protection port (LDPE pipe ø10 mm) (**W1.1.2**)

Water condensed from the O₂ and H₂ vent is drained from this port. In case of excessive presence of water due to overfilling of Electrolysers, this port allows water to pass through the system safely. It should be connected to a drain system without any increase in elevation to allow water to drain with ease: the inclination of the pipe mustn't exceed W1.1.2 bulkhead height.

8. Power conduit (Bulkhead union ø42,5 mm) (**POWER**)

A conduit to connect the cabinet’s power distribution unit, simply insert a cable (PG36) into the conduit and connect it to the power line terminal blocks.

Version	Document Title	Release Date
07	Enapter Indoor Cabinet for Modules 2.1	26 May 2021

Vent management design

The vent consists of two separate outputs:

W1.1.1 – VENT

- This vent needs to be routed outside to a safe area. A steady output of ~250 NL/h per Electrolyser of O₂ (and some small percentage of H₂) is vented via this port. Therefore, the output should be similarly routed to a safe area as the hydrogen purge. The total length of the vent pipe connected to W1.1.1 should not exceed 15 meters or cause backpressure exceeding 0.4 barg on the vent outputs of the electrolyses, **at any time**.
- Ensure that the vent line has at least a 1-degree decline towards the top of the cabinet; any condensing water must be allowed to run back into the drain trap in the CAB21.
- The vent **must not** be obstructed at any time, ensure that necessary steps are taken that the output does not become clogged or frozen shut.

W1.1.2 – OVERFILLING

- The water is separated from the rest of the vent output in a water trap located on the left side of the cabinet, just behind the side panel. A steady stream of around 20 g/hr per Electrolyser has to be drained.
- The output **must not** be obstructed; water should be allowed to drain out of the line with ease. Ensure the line is not raised 20 cm above ground level, so the water has an easy way of draining out of the system.
- If the User suspects for any reason that the water trap is not functioning, he can access it from the front side of the cabinet (or by removing the left side panel if it is not accessible)

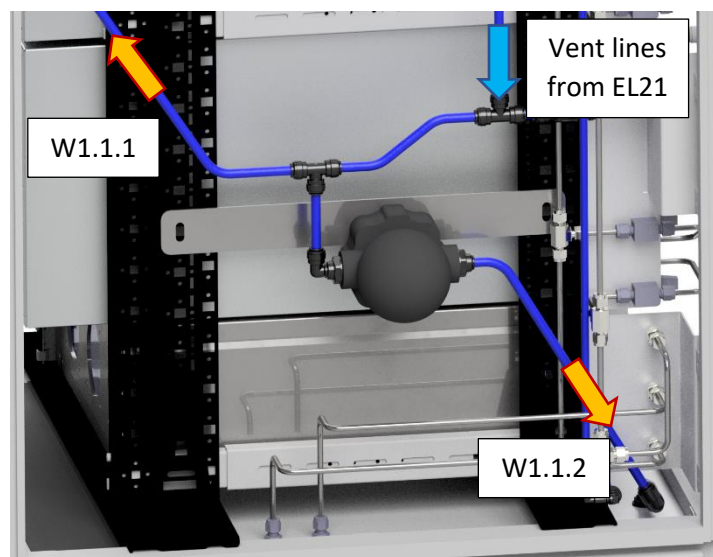

Figure 20: Water trap

Version	Document Title	Release Date
07	Enapter Indoor Cabinet for Modules 2.1	26 May 2021

Management of airflow

The intakes and vents should not be obstructed. The airflow must enter from the front and exit from the back, passing through the modules (Figure 17).

As previously stated, space must be kept in front and behind the cabinet, equal to the width of the cabinet and 1.2 meters and 0.5 meters in length, respectively (Figure 18).



Figure 17: Air flow

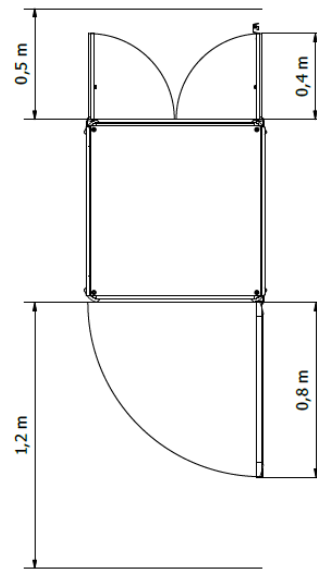

Figure 18: Free space around the cabinet



Version	Document Title	Release Date
07	Enapter Indoor Cabinet for Modules 2.1	26 May 2021

FIRST TIME SETUP OF THE CABINET SYSTEM

After carefully preparing and assembling each module and making the connections, carry out another general check. Turn the system on and make sure there are no leakages from the Hydrogen and water systems.

TRANSPORT, MAINTENANCE AND RECYCLING

The cabinet IP20 is designed to provide many hours of service with minimal maintenance. Proper care and maintenance by qualified personnel will help maximise the operating life of the unit.

Remove all modules contained within the cabinet before shipping and transport.

Routine maintenance

The unit should be inspected annually for obvious signs of physical deterioration.

Hydrogen and water connections should be tested for leakage using a combustible gas detector and visual inspection, whenever general maintenance is performed on systems contained within the cabinet.

You are ready to use the cabinet.

Enjoy it!